



MEN
End Suction Water Pump

MEN – MENBLOC



Experience In Motion

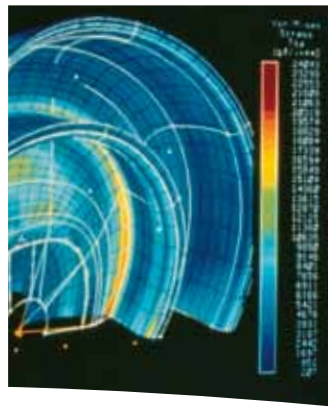

Pump Supplier to the World

Flowserve is the driving force in the global industrial pump marketplace. No other pump company in the world has the depth or breadth of expertise in the successful application of pre-engineered, engineered, and special purpose pumps and systems.

Life Cycle Cost Solutions

Flowserve provides pumping solutions that permit customers to reduce total life cycle costs and improve productivity, profitability and pumping system reliability.

Market-Focused Customer Support

Product and industry specialists develop effective proposals and solutions directed toward market and customer preferences. They offer technical advice and assistance throughout each stage of the product life cycle, beginning with the initial inquiry.

Broad Product Lines

Flowserve offers a wide range of complementary pump types, from pre-engineered process pumps to highly engineered and special purpose pumps and systems. Pumps are built to recognized global standards and customer specifications.

Pump designs include:

- Single-stage process
- Between bearings single-stage
- Between bearings multistage
- Vertical
- Submersible motor
- Positive displacement
- Nuclear
- Specialty

Product Brands of Distinction

ACEC™ Centrifugal Pumps

Aldrich™ Pumps

Byron Jackson® Pumps

Calder™ Energy Recovery Devices

Cameron™ Pumps

Durco® Process Pumps

Flowserve® Pumps

IDP® Pumps

Niigata Worthington™ Pumps

Pacific® Pumps

Pleuger® Pumps

Scienco™ Pumps

Sier-Bath® Rotary Pumps

TKL™ Pumps

United Centrifugal® Pumps

Western Land Roller™ Irrigation Pumps

Wilson-Snyder® Pumps

Worthington® Pumps

Worthington Simpson™ Pumps

**MEN
End Suction
Water Pump**



**Complementary
Pumps**

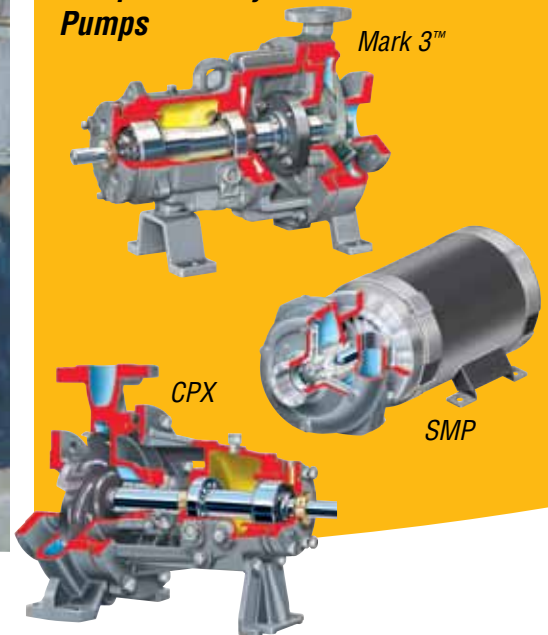

**Rugged Construction,
Reliable Performance**

The MEN family of single-stage, end suction water pumps provides a broad range of hydraulic coverage and low total cost of ownership. This family of pumps delivers maximum mechanical and hydraulic flexibility. Available in both frame mounted and close coupled configurations, the MEN family of pumps is ruggedly designed to provide long, reliable performance in a variety of water services.

Significant Benefits

MEN end suction water pumps are engineered to provide significant benefits for users.

- Superior pump performance
 - Low NPSHR
 - Quiet operation
 - Efficient operation
- Low total life cycle costs
 - Optimal hydraulic selection
 - Lower energy costs
 - Reduced inventory requirements
 - Reduced maintenance costs
 - Increased uptime
- Versatility
 - Multiple configurations
 - Parts interchangeability

Applications

- Water supply
- Water treatment
- Irrigation
- Drainage
- Filter cleaning
- Fire protection
- General industry
- Water circulation
- HVAC

Complementary Pump Designs

Flowserve also can provide the following complementary pump designs:

- SMP standard motor pump
- SMX non-metallic standard motor pump
- CPX ISO chemical process pump
- CPXV ISO vertical sump pump
- Mark 3 ASME chemical process pump
- ESP3 vertical immersion sump pump
- FRBH heavy-duty paper stock and process pump
- ME end suction water pump
- MHP frame mounted, single volute, high-pressure pump
- DS end suction process pump
- LR between bearings, axially split pump

MEN
End Suction
Water Pump

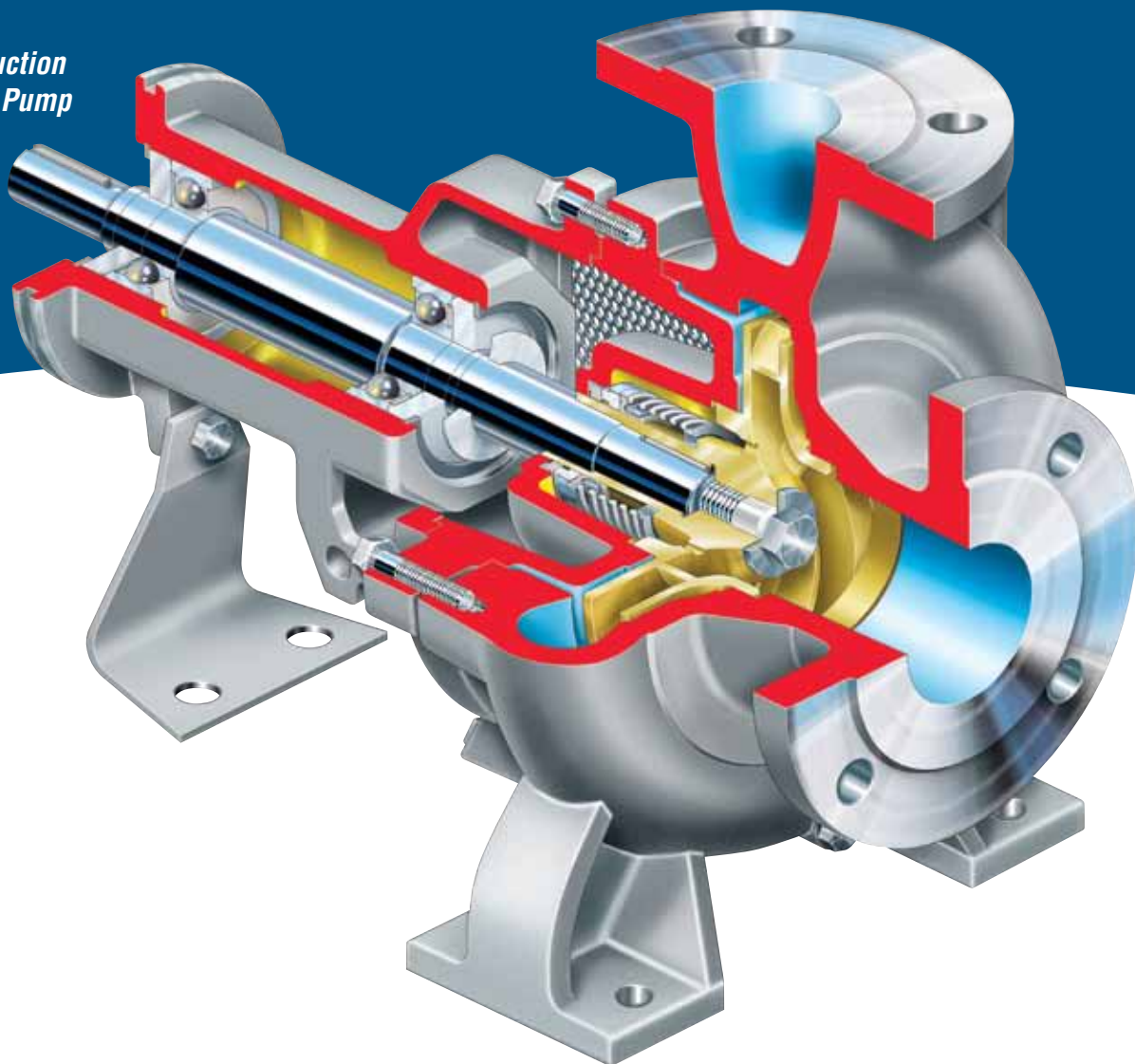

The rugged and reliable MEN end suction water pump is the preferred choice for general purpose water applications. The dependable MEN promotes parts interchangeability among pump sizes and configurations. The resulting reduction in inventory costs, along with the MEN's optimal hydraulics and minimal maintenance needs, provides users with significant cost savings.

MEN water pumps destined for Europe are CE marked and comply with the dimensional requirements of the latest editions of EN 733 and DIN 24 255.

Operating Parameters

- Flows to 800 m³/h (3520 gpm)
- Heads to 140 m (450 ft)
- Pressures to 16 bar (230 psi)
- Temperatures from -10°C (15°F) to 120°C (250°F)
- Speeds to 3500 rpm

Volute Casing Design has raised face flanges to ISO PN 10/16 or ANSI B16.1 specifications.

Precision Cast Closed Impeller with extended hub has machined shrouds and is dynamically balanced for high efficiency. Axial thrust is minimized by balancing chamber and holes on the rear side.

Sturdy Bearing Housing incorporates greased-for-life, large diameter, reinforced ball bearings protected by thrower and covers.

Open Seal Chamber features integral vortex breaking ribs to extend the life of mechanical seals.

Oversized Stainless Steel Shaft is conservatively designed to minimize deflection and reduce wear.

Back Pull-Out Design facilitates inspection and maintenance.

Optional ISC Seal



Elastomeric Bellows Mechanical Seal

The MEN pump comes standard with an internal, elastomeric bellows mechanical seal that is inexpensive and highly dependable. The bellows' high strength and flexibility is key to the seal's reliable performance in a wide range of applications. Bidirectional in operation, the seal readily accommodates misalignment, end-float and seal face wear. Furthermore, this design is widely used throughout the water industry, making spare parts readily available.

The MEN pump is also available with an optional ISC single pusher cartridge seal for more demanding applications. The ISC features non-wetted springs for reduced corrosion and optimized carbon and silicon carbide cross sections for stable performance.

For those applications in which a mechanical seal is not needed, packing is also available with the MEN pump.

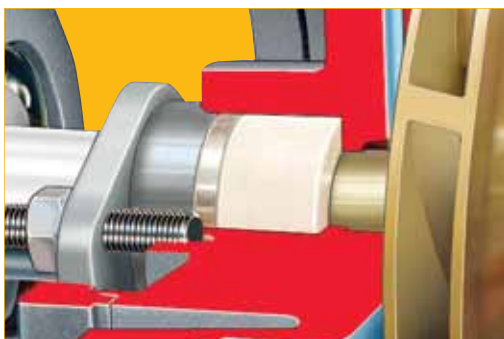

Optional Packed Gland



MENBLOC Close Coupled Design

MENBLOC is the close coupled configuration of the MEN water pump. Not requiring a baseplate or coupling, it is an economical alternative to the frame mounted MEN. Its reduced footprint also permits its use in tight areas.

MENBLOC pumps intended for use in Europe are CE marked. Wet-end components comply with the latest editions of the EN 733 and DIN 24 255.

Operating Parameters

- Flows to 340 m³/h (1500 gpm)
- Heads to 100 m (330 ft)
- Pressures to 16 bar (230 psi)
- Temperatures to 110°C (230°F)

Options and Technical Data



Available Configurations

Available in 33 sizes, the MEN family of water pumps consists of multiple designs with varied hydraulic capabilities to meet application needs. They include the following configurations:

- MEN frame mounted standard water pump
- MENBLOC close coupled standard water pump
- MEN-SP cantilever sump pump
- MEN-TI diesel-driven fire pump

Options to Suit Application Needs

- ISO or ANSI flanges
- Grease lubricated bearings
- Casing wear rings
- Packing or mechanical seal

Materials of Construction

Description	Standard	Options
Casing	Cast Iron	Stainless Steel
Casing Cover With Stuffing Box	Cast Iron	Stainless Steel
Wear Ring		13% Chromium Steel
Impeller	Cast Iron or Bronze	Stainless Steel
Bearing Housing	Cast Iron	
Shaft	13% Chromium Steel	Other Chromium Steel*

* Consult factory or a Flowserve representative

MEN Range Chart

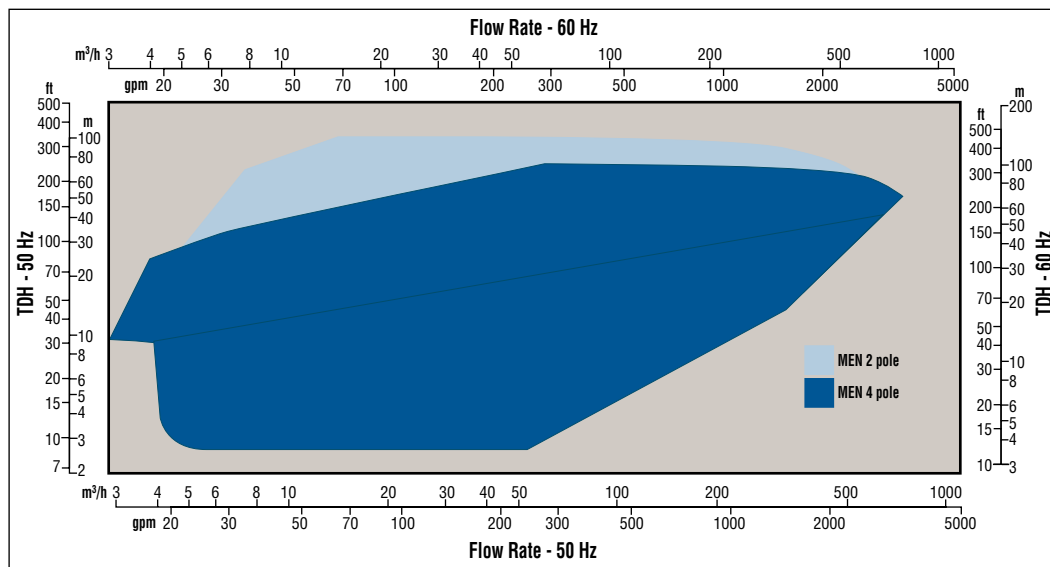

Global Service
and Technical
Support



Life Cycle Cost Solutions

Typically, 90% of the total life cycle cost (LCC) of a pumping system is accumulated after the equipment is purchased and installed. Flowserve has developed a comprehensive suite of solutions aimed at providing customers with unprecedented value and cost savings throughout the life span of the pumping system. These solutions account for every facet of life cycle cost, including:

Capital Expenses

- Initial purchase
- Installation

Operating Expenses

- Energy consumption
- Maintenance
- Production losses
- Environmental
- Inventory
- Operating
- Removal

Innovative Life Cycle Cost Solutions

- New Pump Selection
- Turnkey Engineering and Field Service
- Energy Management
- Pump Availability
- Proactive Maintenance
- Inventory Management

Typical Pump Life Cycle Costs¹

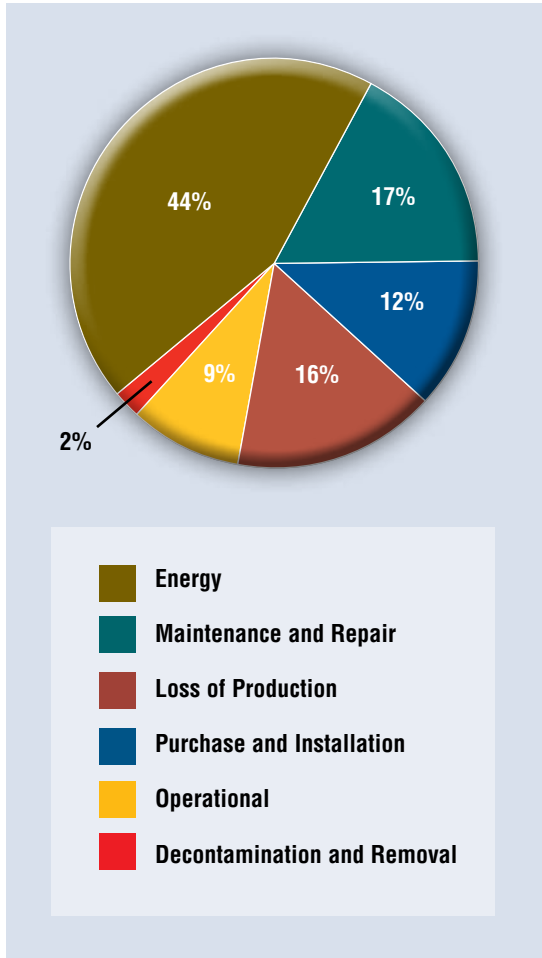

¹ While exact values may differ, these percentages are consistent with those published by leading pump manufacturers and end users, as well as industry associations and government agencies worldwide.

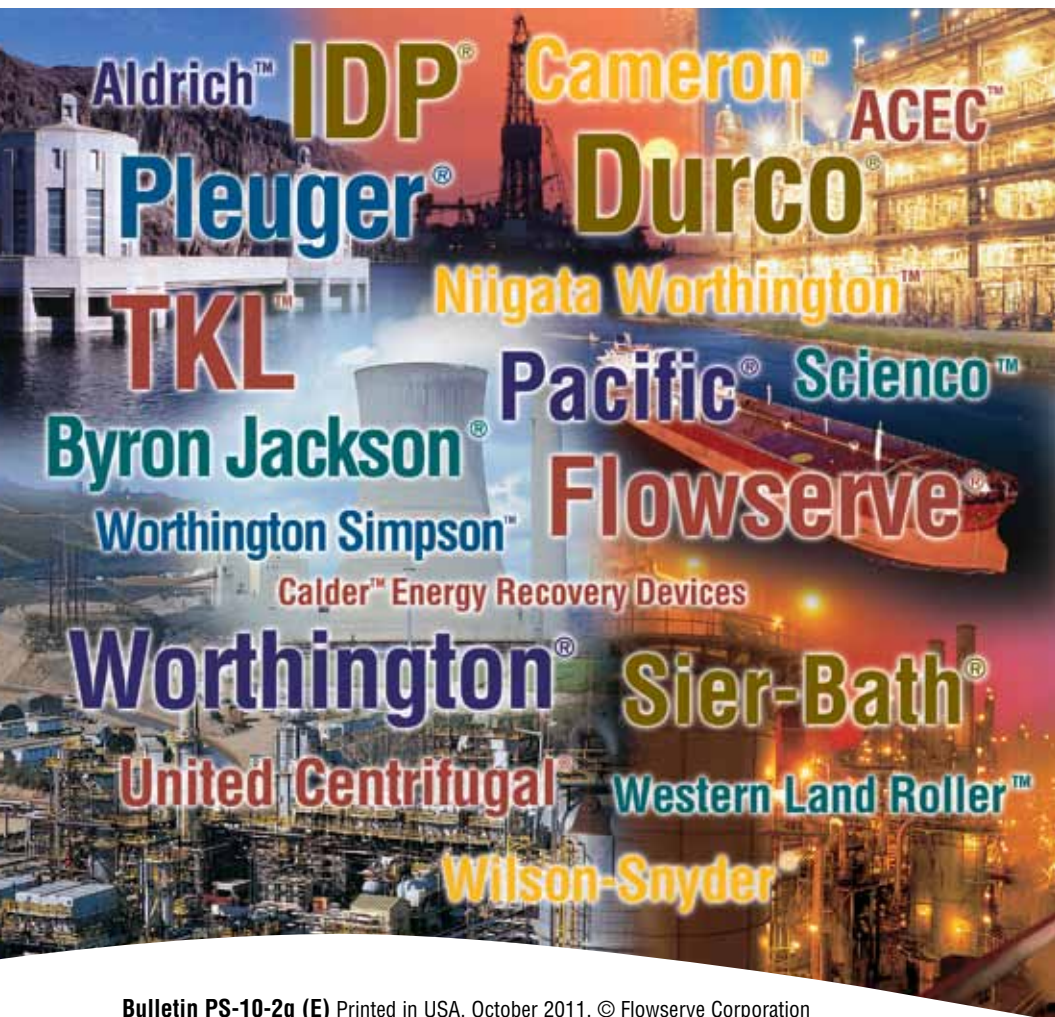

USA and Canada
Flowserve Corporation
5215 North O'Connor Blvd.
Suite 2300
Irving, Texas 75039-5421 USA
Telephone: +1 937 890 5839

Europe, Middle East, Africa
Flowserve Corporation
Parallelweg 13
4878 AH Etten-Leur
The Netherlands
Telephone: +31 76 502 8100

Latin America
Flowserve Corporation
Martín Rodríguez 4460
B1644CGN-Victoria-San Fernando
Buenos Aires, Argentina
Telephone: +54 11 4006 8700
Telefax: +54 11 4714 1610

Asia Pacific
Flowserve Pte. Ltd.
10 Tuas Loop
Singapore 637345
Telephone: +65 6771 0600
Telefax: +65 6862 2329

Bulletin PS-10-2g (E) Printed in USA. October 2011. © Flowserve Corporation

To find your local Flowserve representative:

For more information about Flowserve Corporation, visit www.flowserve.com or call +1 937 890 5839.